

ALLIS CHALMERS

FORD

AA14-4RS

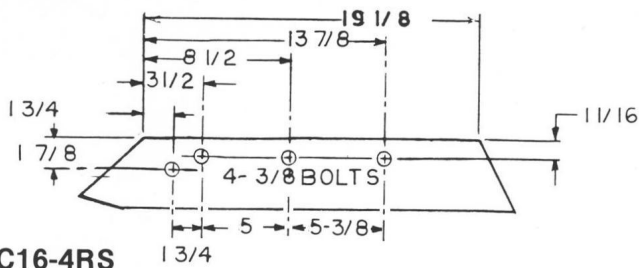

AC16-4RS

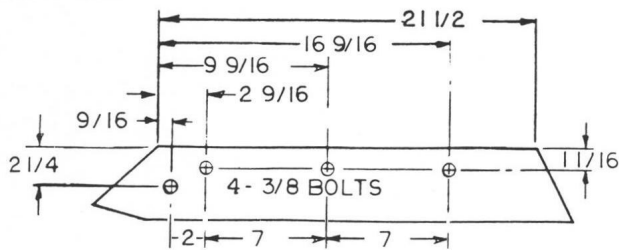

AM14-4RS

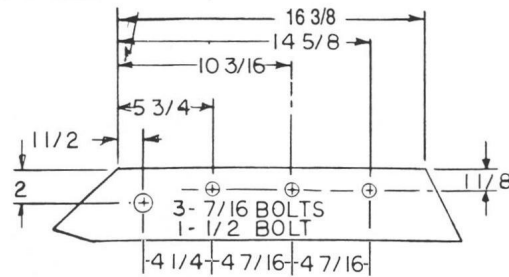

AM16-4RS

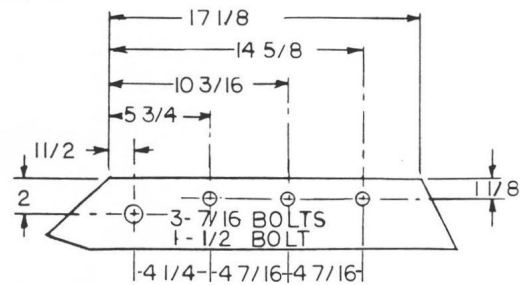

AM18-4RS

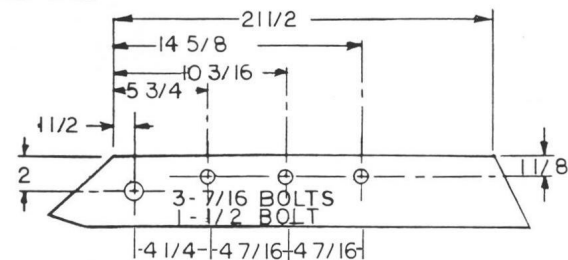

FF12-2RS

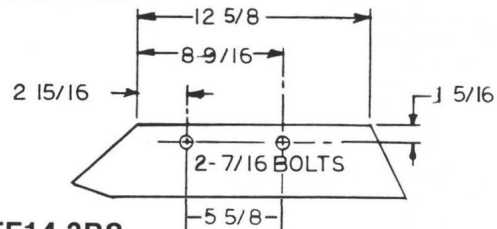

FF14-3RS

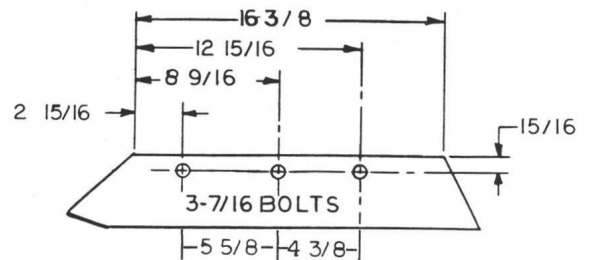

FF16-3RS

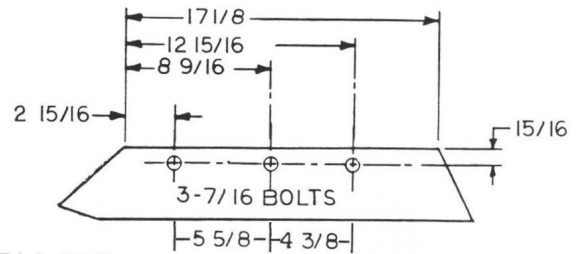

FF14-4RS

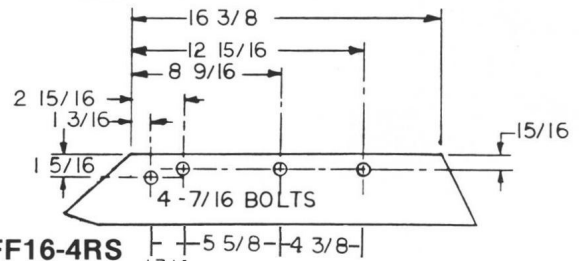

FF16-4RS
FF16-4LRS

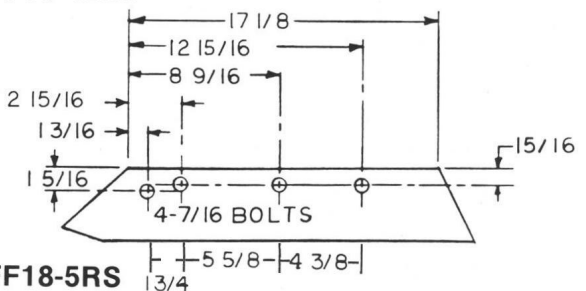

FF18-5RS

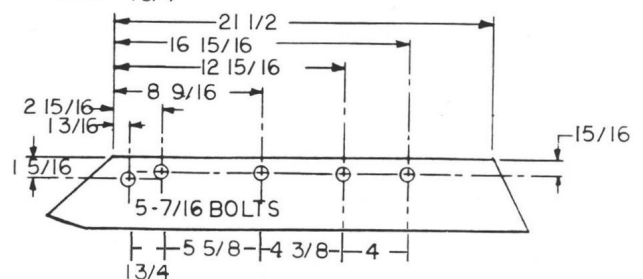

IHC

MI14-3RS

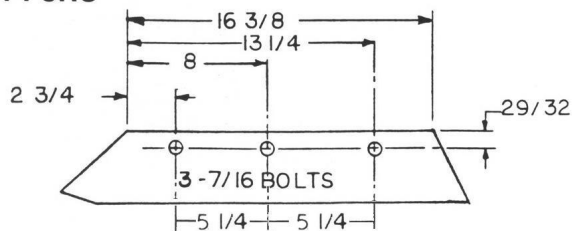

MI16-3RS

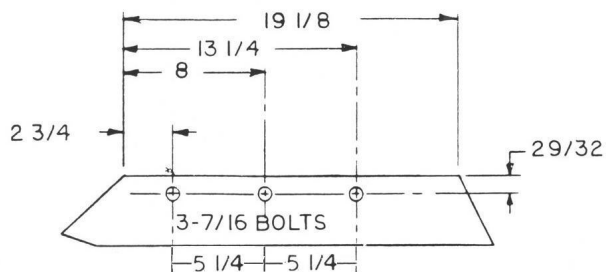

IH14-4RS

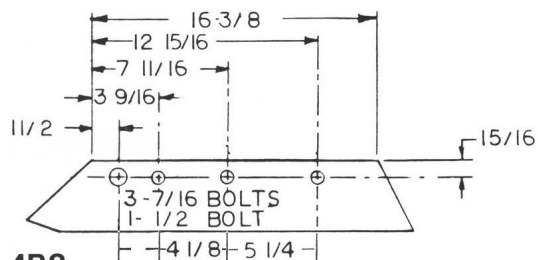

**IH16-4RS
IH16-4LRS**

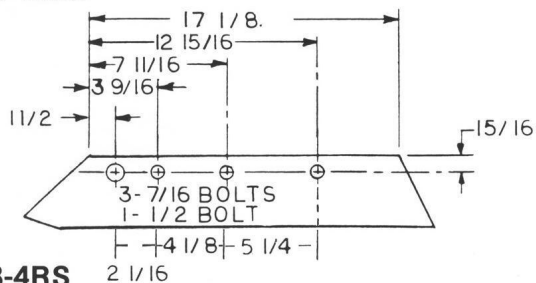

**IH18-4RS
IH18-4LRS**

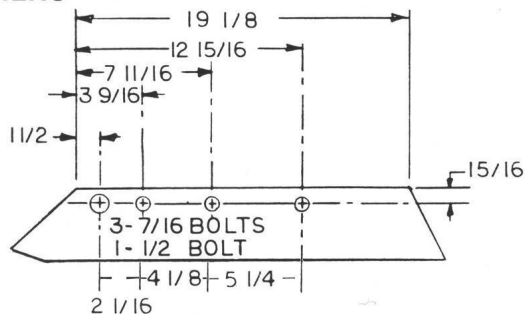

J. I. CASE

CA16-3RS

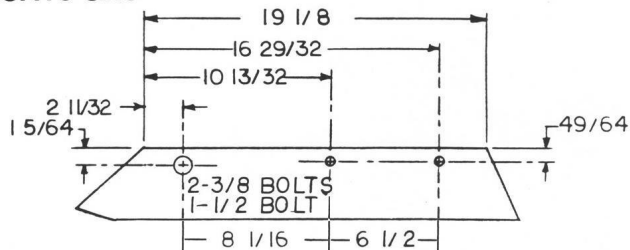

**CA16-4RS
CA16-4LRS**

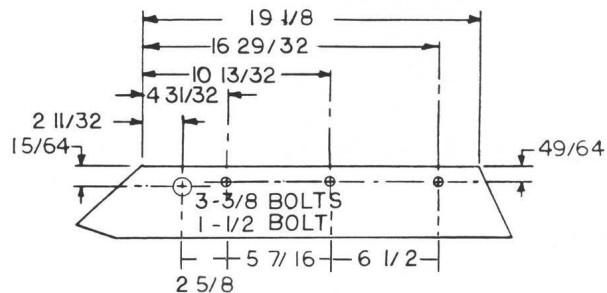

JOHN DEERE

JD14-3RS

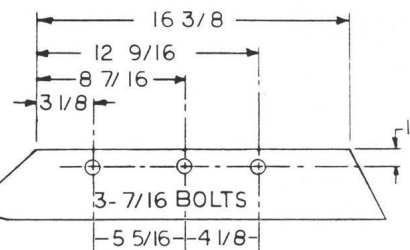

JD16-3RS

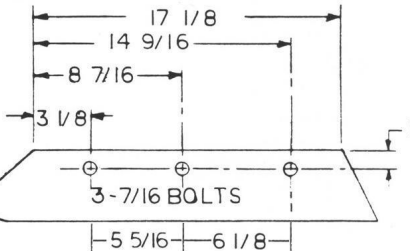

JD14-4RS

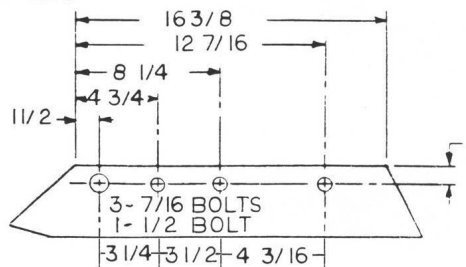

JOHN DEERE

JD16-4RS JD16-4LRS

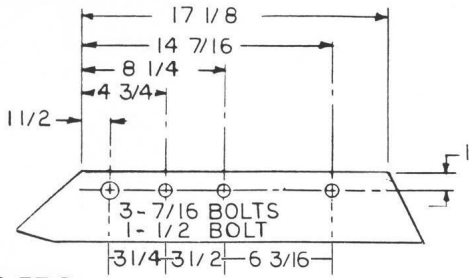

JD18-5RS JD18-5LRS

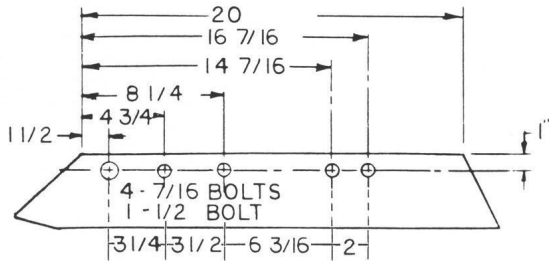

JD18-3RS

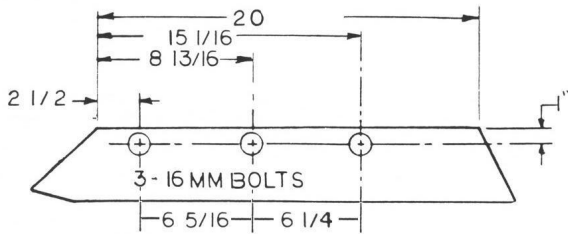

MASSEY FERGUSON

MI14-3RS

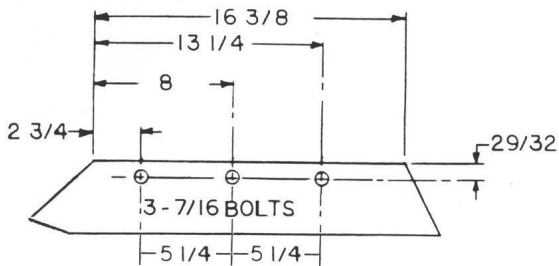

MI16-3RS

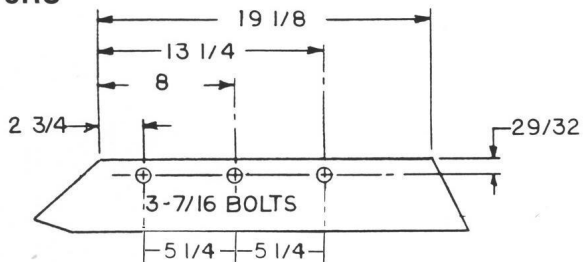

MF14-4RS

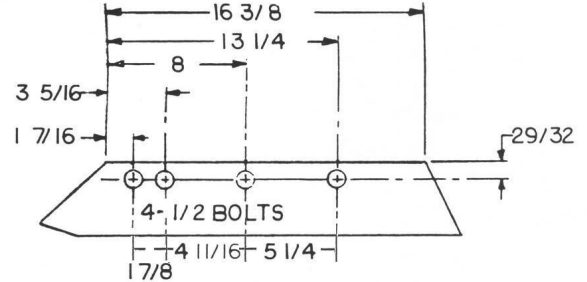

MF16-4RS MF16-4LRS

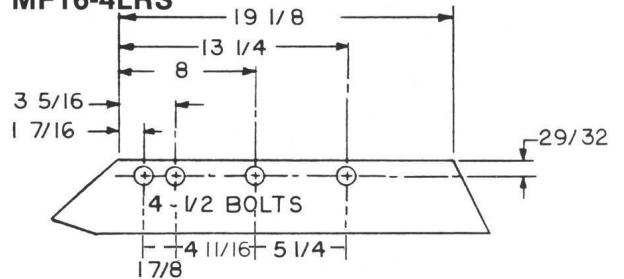

MF18-4RS MF18-4LRS

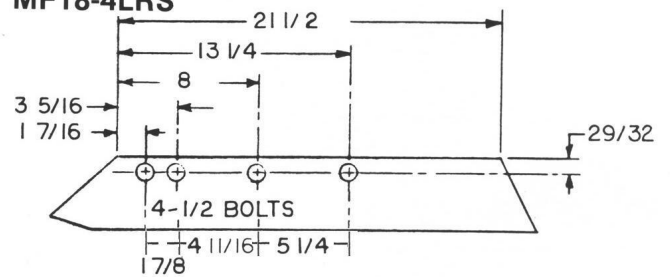

MELROE

MM14-4RS

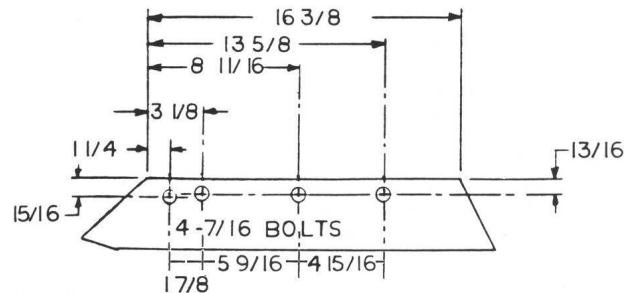

MM16-4RS

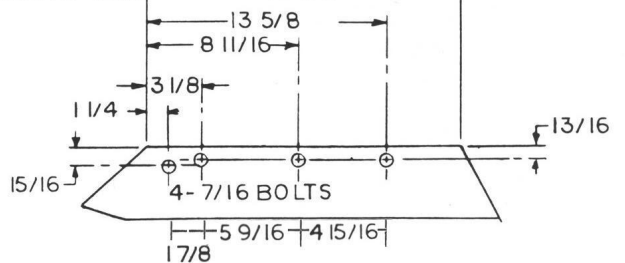

MM18-4RS

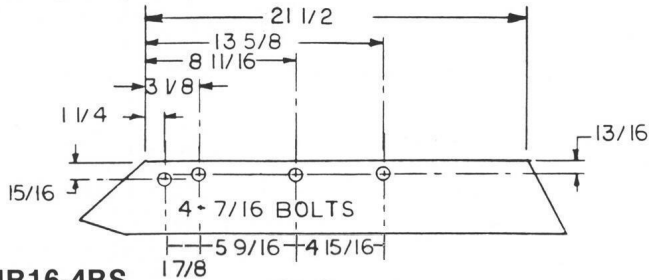

MR16-4RS

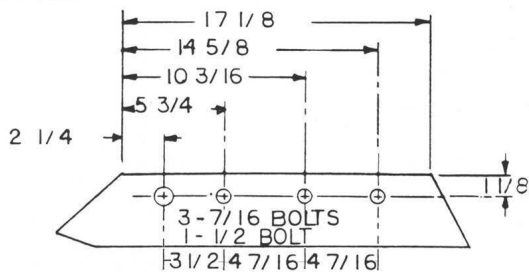

MR18-4RS

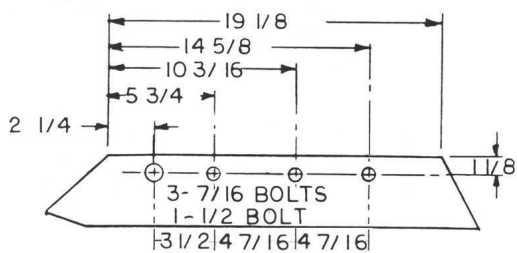

OLIVER-WHITE-M&M

OM14-4RS

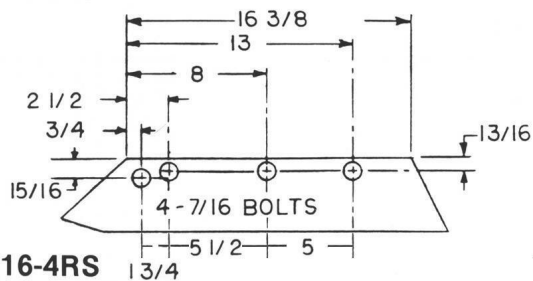

**OM16-4RS
OM16-4LRS**

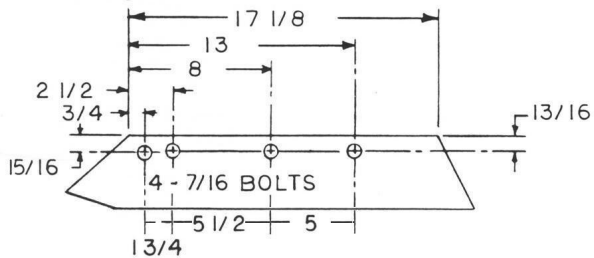

**OM18-5RS
OM18-5LRS**

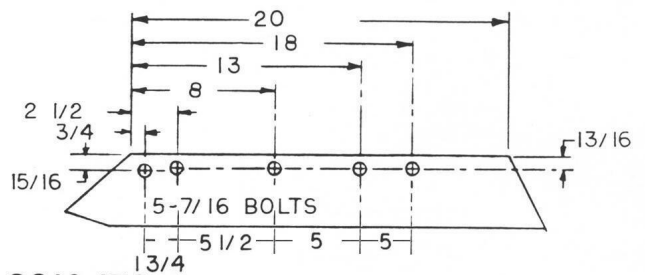

**OC16-4RS
OC16-4LRS**

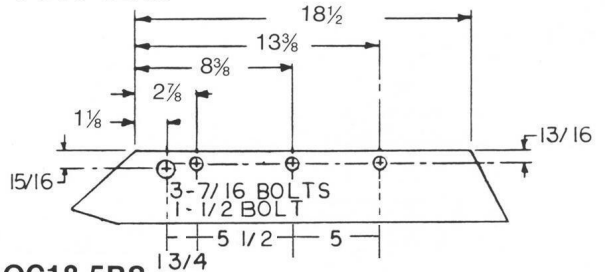

**OC18-5RS
OC18-5LRS**

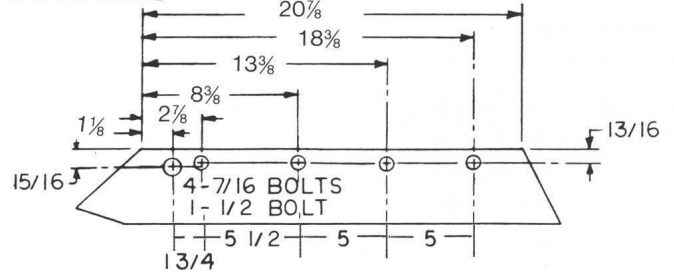

OC20-5RS

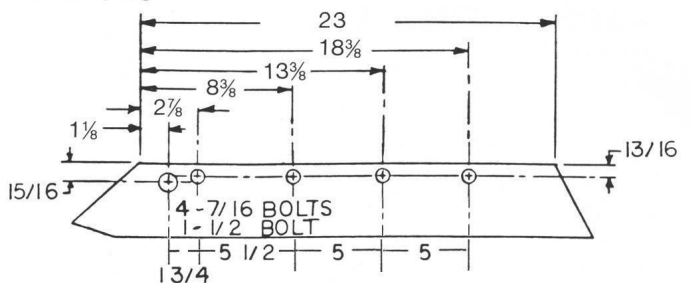

OD18-5RS

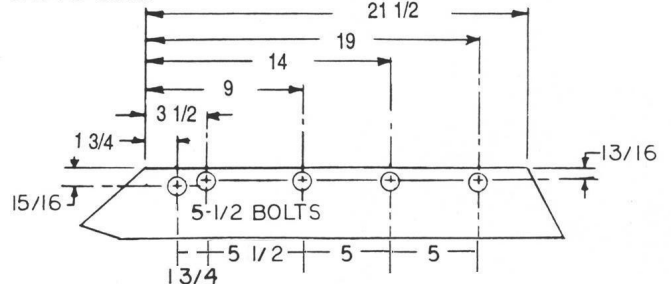

DMI

DM16-4RS

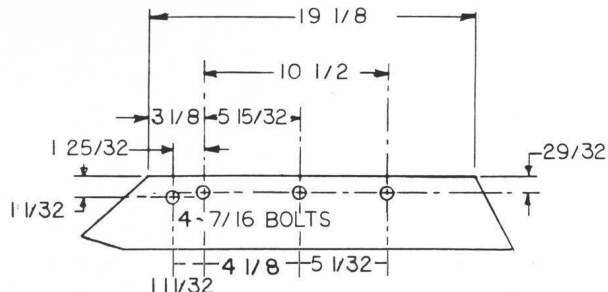

DM18-4RS

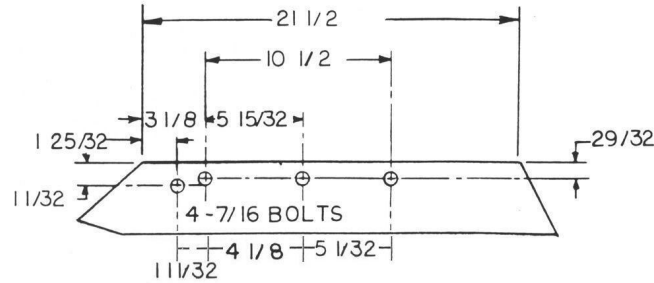

WIL-RICH

WR16-4RS

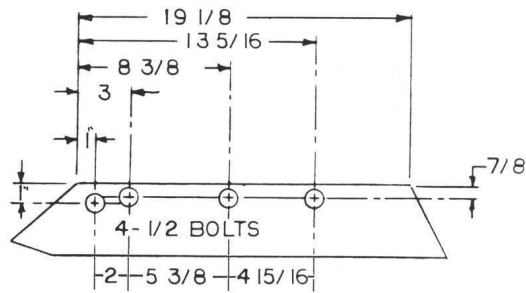

WR18-4RS

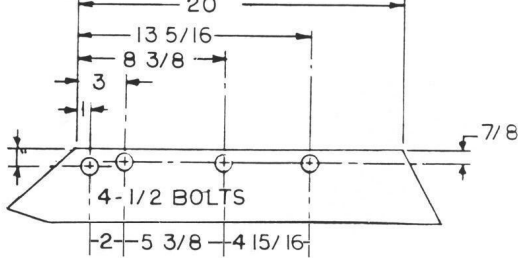

WATTS

WA18-4RS

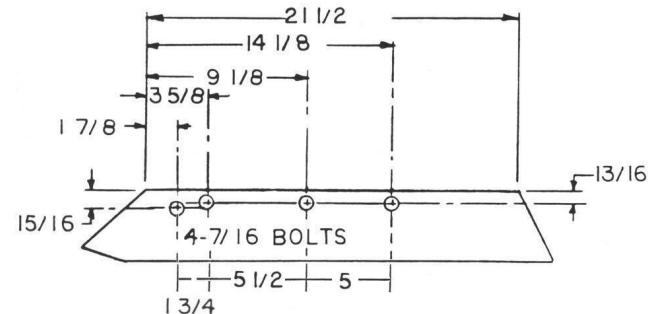

HARRELL

HA24-5RS

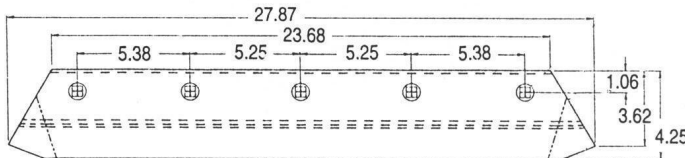

BAKER

BA25-6RS

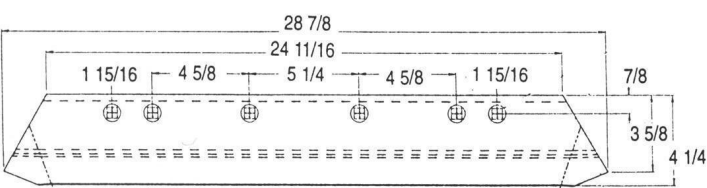

JOHN DEERE

JD24-4RS

